

# Architectural Grade Side Bend LED Neon Flex (12X20mm)

## Features and Specifications



### KEY HIGHLIGHTS

The LED Flexible Neon Strip is a high-performance linear lighting solution designed to deliver uniform, dot-free illumination with the visual effect of traditional neon light.

Utilizing advanced encapsulation technology and a high-density LED strip, it provides smooth, continuous light output with excellent brightness consistency. Constructed with a durable, UV-resistant and IP65-rated silicone housing, the strip is suitable for indoor and outdoor applications. Its flexible structure with Side bend feature allows for curved and creative installations.

Customizable lengths and cuttable sections ensure ease of installation.



### TECHNICAL SPECIFICATIONS

Input Voltage:	24V DC
Color:	1800K/2400K/2700K/3000K/4000K/6500K/Red/Green/Blue
Bending Direction:	Side Bend
Reel Length:	5 Meters (16.4')
Lead Wire:	.15m to 2.5m customizable (2-Line)
IP Rating:	IP65 (Waterproof/Outdoor Rated)
Material:	UV-Resistant Silicone
Wattage:	12W/m (3.6W/ft)
Dimmable:	Yes
CRI:	90+
Cutting Unit:	50mm
Dimensions:	12mm x 20mm (W x H)
Luminous Flux/m:	600~660lm



### FEATURES

- ETL, CE, RoHS, CCC certified.
- CA Title 24: Compliant with approved drivers; consult factory for details.
- Operating Temperature: -20°C to 50°C (-4°F to 122°F)
- Storage Space Ready: Complies with NEC (NFPA 70) 410.16 requirements for closet installations.



### WARRANTY

- 5-year coverage guaranteed when utilized with luzumi led approved power supply.

Note: The Warranty Period begins on the date of original shipment from our factory, the warranty covers product only and does not cover any labor or incidental charges related to service or warranty. This Warranty applies only to the original purchasers or authorized distributors.

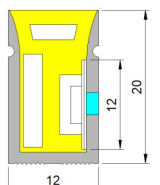

# Architectural Grade Side Bend LED Neon Flex (12X20mm)

## Features and Specifications



### HOW TO ORDER A LUZUMI LED NEON TAPE LIGHT

Name	Wattage/m	Color	Neon Dimensions	Bend Type	FPC Width(mm)	IP Rate	Voltage
FN	10W	W (18K, 27K, 30K, 40K, 65K)	1212	3D	8	A (IP65)	24
	12W	R	1616	T	10	B (IP68)	120
	13W	G	2020	S	12		230
	14W	B	2012	R			
	15W	RGB+W (27K, 30K, 35K, 40K, 50K, 65K)	0406				
		TW(Tunable White)	and more...				



Example: FN12W-W2012-S12A24

### MECHANICAL DIAGRAMS

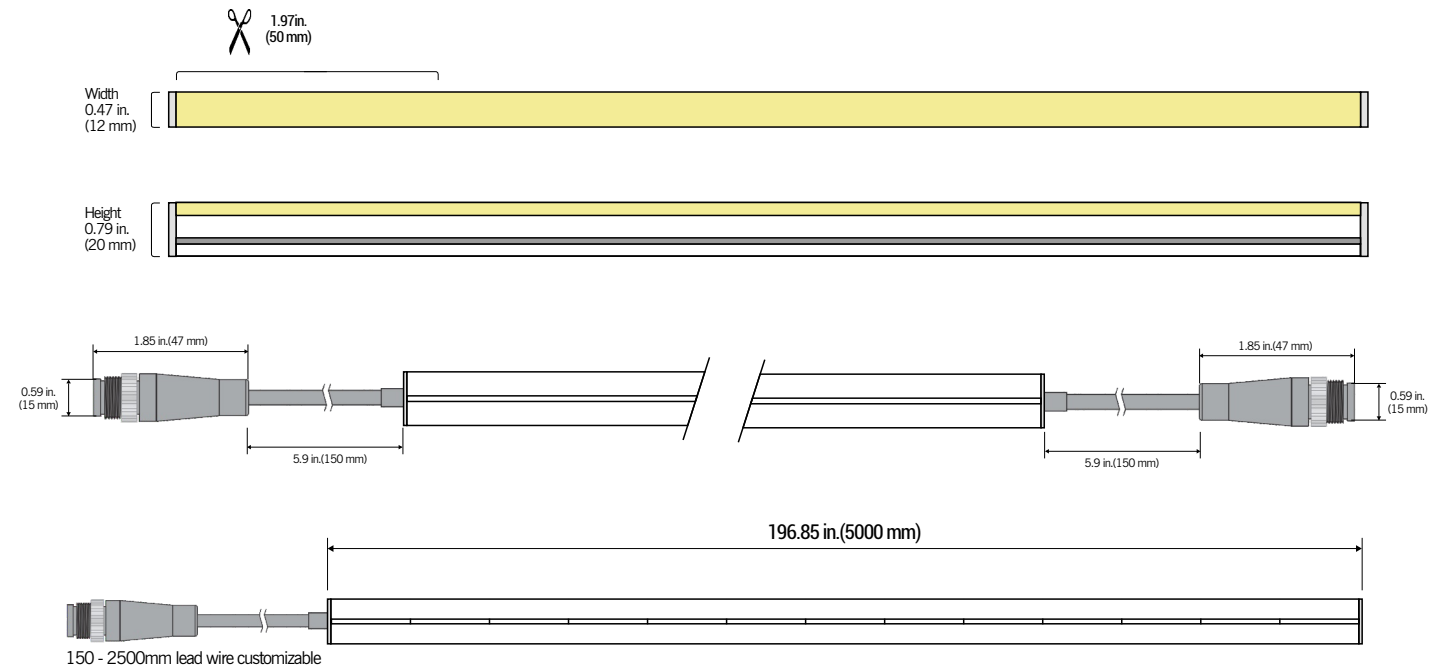

### Lead Wire Options

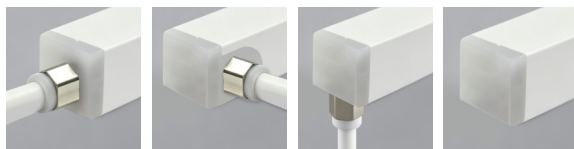

Front Side Bottom Closed End

### Side Bend

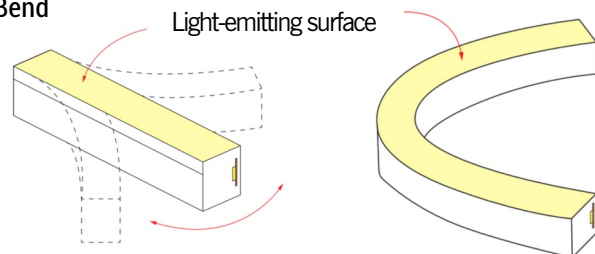

Use professional scissors to cut vertically at the cutting mark.

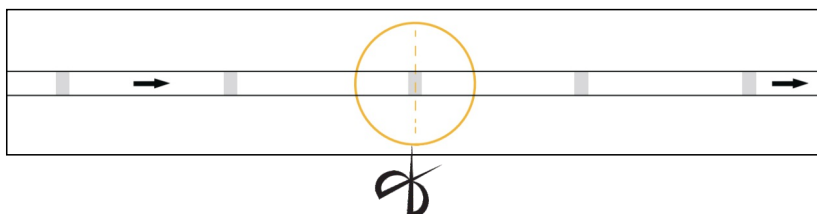

# Architectural Grade Side Bend LED Neon Flex (12X20mm)

## Features and Specifications



### ACCESSORIES

#### ALUMINIUM MOUNTING CLIPS / ALUMINIUM PROFILE FOR 12x20 LED NEON

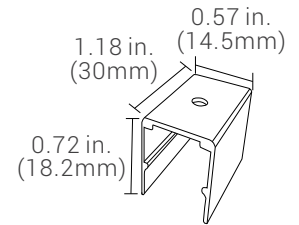
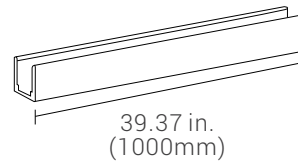
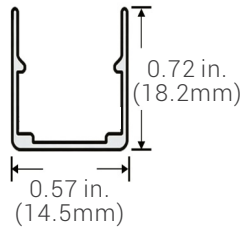
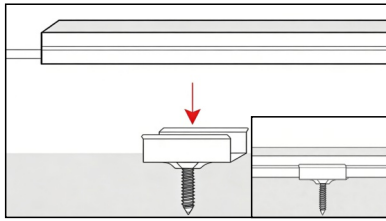

#### ALUMINIUM MOUNTING CLIPS / ALUMINIUM PROFILE FOR 12x20 LED NEON

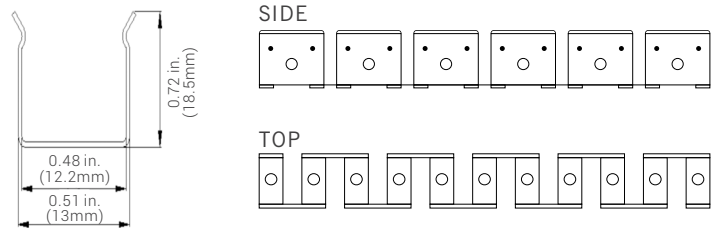
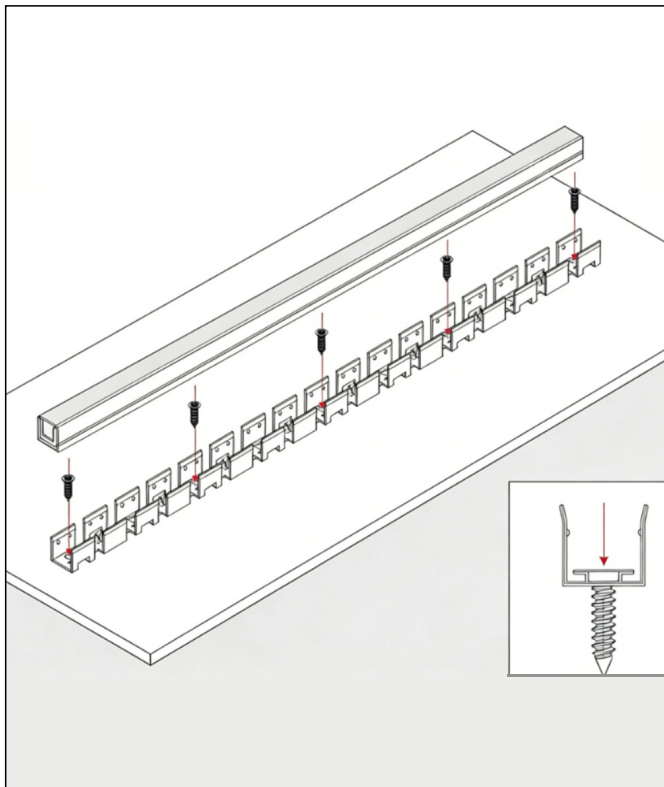

#### Mounting Option 1 (Aluminum Channel Profile)

Screw the channel onto the surface and press the Neon Strip inside, aligning the connector with the edge. For factory-assembled units, the complete Neon Strip fits directly into the channel.

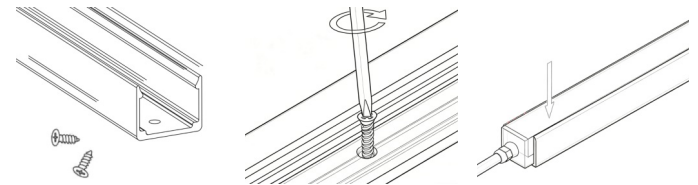

#### Mounting Option 2 (U Clip)

Secure the bottom U-clips to the surface using mounting screws at intervals of at least every 250mm. Once secured, press the Neon Strip firmly into the clips.

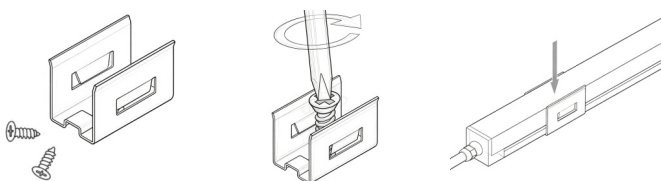

#### Mounting Option 3 (Stainless Steel Spine Channel)

Secure the stainless steel spine channel to the surface with mounting screws. Press the Neon Strip into the channel, ensuring the connector is flush with the spine channel's edge. For factory-assembled units, the entire Neon Strip is designed to sit fully within the spine channel.

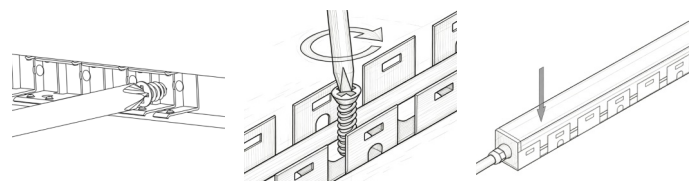

# Architectural Grade Side Bend LED Neon Flex (12X20mm)

## Features and Specifications



### System Wiring Diagrams

The diagram below illustrates a standard system configuration. For larger installations or custom setups, please visit our website or contact technical support. Before beginning, consult the specific installation guides for each component to ensure you have the most current wiring instructions. All installations must comply with national and local electrical codes. Note that wiring configurations may vary depending on your specific power and dimming requirements.

### Single Color System Diagram

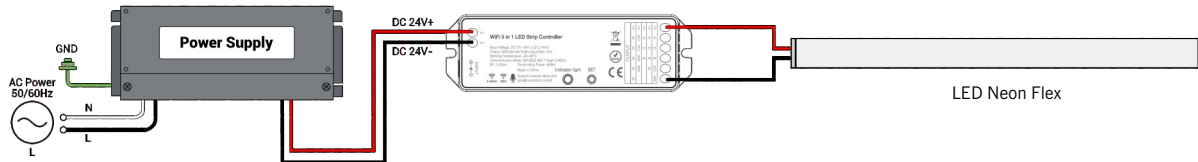

## Common Controllers for LED Neon and Tape Light

### Panel Controller 2.4G RF



P0 (Black)  
2 in 1 Rotating Panel Controller  
(Single Color / Dual White)



P0 (White)  
2 in 1 Rotating Panel Controller  
(Single Color / Dual White)

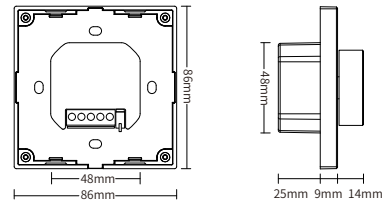

Model No.	Output Mode	Output Current	Input Voltage	Total Output	Output Power	Working Temp.	Control Signal	Control Distance
P0	2 in 1	DC12V~48V	12A/Channel	Max 12A	144-576W	-10~40°C	2.4G RF	30m

### 2.4G+Wifi Series (built in wifi chip, no need gateway)

#### 5 in 1 LED Controller Tuya WiFi + 2.4G RF

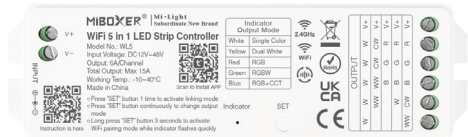

5 in 1 LED Controller  
(Single Color / Dual White / RGB / RGBW / RGB+CCT)

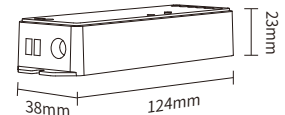

Model No.	Output Mode	Input Voltage	Output Current	Total Output	Output Power	Working Temp.	Control Signal	2.4G RF Distance
WLS5	5 in 1	DC12V~48V	6A/Channel	Max 15A	180-720W	-10~40°C	Tuya app + 2.4G RF	30m

### 2.4G LED Controller Kits 2.4G RF

Controller kits: save money, cheaper than you purchase controller and remote separately.



FUT035SA+  
2 in 1 LED Controller Kits  
(Single Color / Dual White)

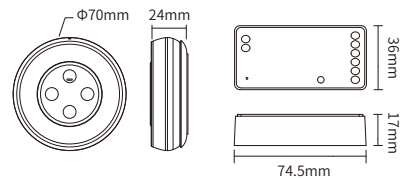

#### Remote Parameters

Working Voltage	Standby Power Consumption	Transmitting Power	RF	Working Temp.	Control Distance
3V(AAA * 2PCS)	15μA	6dBm	2.4GHz	-10~40°C	30m

#### Controller Parameters

Model No.	Output Mode	Input Voltage	Output Current	Total Output	Output Power	Working Temp.	Control Signal	Control Distance
FUT035SA+	2 in 1	DC12V~24V	12A/Channel	Max 12A	144-288W	-10~40°C	2.4G RF + PUSH	30m

# Architectural Grade Side Bend LED Neon Flex (12X20mm)

## Features and Specifications



### Waterproof 5 in 1 LED Controller



WLS-WP   + 2.4G RF   
5 in 1 LED Controller  
(Single Color / Dual White / RGB / RGBW / RGB+CCT)

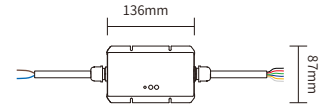
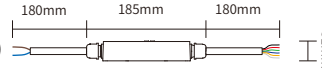

Model No.	Output Mode	Input Voltage	Output Current	Total Output	Output Power	Working Temp.	Control Signal	2.4G RF Distance
WLS-WP	5 in 1	DC12V~48V	10A/Channel	Max 20A	240-960W	-20~45°C	Tuya app + 2.4G RF	30m

## Power Supplies for LED Neon and Tape Light

### Constant Voltage Metal Power Supply (Non-waterproof, IP20)



Model No.	AC input voltage range	Output
SL-V-12XXXX (SL-V-24XXXX)	100-240V	DC 12V or 24V, Max. Output Options: 15W,35W,50W,60W,70W,100W,120W,200W,250W,300W,350W,400W,500W,600W

### Constant Voltage 0-10V Dimmable LED Power Supply (Waterproof, IP66)



Model No.	AC input voltage range	Output
SL-VB-12XXX-A-DIM (SL-VB-24XXX-A-DIM)	180-250 VAC 100-130 VDC	DC12V or 24V, Max. Output Options Output : 30W, 45W, 100W, 150W, 180W, 200W

### Constant Voltage Metal Power Supply (Non-waterproof, IP20)



Model No.	AC input voltage range	Output
SL-V-12XXXXPU (SL-V-24XXXXPU)	90-264V	DC 12V or 24V, Max. Output Options: 12W,24W
SL-V-12XXXXP (SL-V-24XXXXP)	90-264V	DC 12V or 24V, Max. OutputOptions: 36W,48W,60W

### Constant Voltage Triac Dimmable LED Power Supply (Non-waterproof, IP20)



Model No.	AC input voltage range	Output
SL-V-12XXX-T-DIM (SL-V-24XXX-T-DIM)	180-250 VAC 100-130 VDC	DC12V or 24V, Max. Output Options Output : 20W, 30W, 45W

### Constant Voltage Power Supply (Waterproof, IP67)



Model No.	AC input voltage range	Output
SL-V-12XXXX (SL-V-24XXXX)	170-250V	DC12V or 24V, Max. Output Options Output : 10W, 20W, 30W, 45W, 60W, 100W, 150W, 200W

### Constant Voltage Triac Dimmable LED Power Supply (Waterproof, IP66)



Model No.	AC input voltage range	Output
SL-V-12XXX-A-DIM (SL-V-24XXX-A-DIM)	180-250 VAC 100-130 VDC	DC12V or 24V, Max. Output Options Output : 60W, 80W

### Constant Voltage 0-10V Dimmable LED Power Supply (Non-waterproof, IP20)



Model No.	AC input voltage range	Output
SL-V-12XXX-A-DIM (SL-V-24XXX-A-DIM)	180-250 VAC 100-130 VDC	DC12V or 24V, Max. Output Options Output : 20W, 30W