

25mm Round 360° Dynamic CCT LED Neon

Features and Specifications



KEY HIGHLIGHTS

Create immersive, sculptural lighting with the 25mm Round 360° Dynamic CCT Neon.

This 1-inch diameter flexible tube emits a flawless glow from 360 degrees, eliminating dark spots and shadows.

Engineered for Free-Bend flexibility, this "rope of light" can be draped, suspended, or twisted into massive organic shapes.

Featuring Dynamic Tunable White (CCT) technology, it gives you total control over the atmosphere.

Shift seamlessly from a cozy, golden Warm White (1800K) for intimate evenings to a crisp, energizing Cool White (6500K) for daytime focus - all from a single, beautiful Neon fixture.



TECHNICAL SPECIFICATIONS

Input Voltage:	24V DC
CCT range:	1800K-6500K. Other CCT range can be customized.
Beam Angle:	360°
Reel Length:	5 Meters (16.4')
Lead Wire:	.15m to 2.5m customizable (3-Line)
IP Rating:	IP65 (Waterproof/Outdoor Rated)
Material:	UV-Resistant Silicone
Wattage:	15W/m (4.6W/ft)
Dimmable:	Yes
CRI:	90+
Cutting Unit:	50mm
Dimensions:	φ 25mm
Luminous Flux/m:	930lm



FEATURES

- ETL, CE, RoHS, CCC certified.
- CA Title 24: Compliant with approved drivers; consult factory for details.
- Operating Temperature: -20°C to 50°C (-4°F to 122°F)
- Storage Space Ready: Complies with NEC (NFPA 70) 410.16 requirements for closet installations.



WARRANTY

- 5-year coverage guaranteed when utilized with luzumi led approved power supply.

Note: The Warranty Period begins on the date of original shipment from our factory, the warranty covers product only and does not cover any labor or incidental charges related to service or warranty. This Warranty applies only to the original purchasers or authorized distributors.

25mm Round 360° Dynamic CCT LED Neon

Features and Specifications



HOW TO ORDER A LUZUMI LED NEON TAPE LIGHT

Name	Wattage/m	Color	Neon Dimensions(Φ)	Bend Type	FPC Width(mm)	IP Rate	Voltage
FN	10W	W (18K, 27K, 30K, 40K, 65K)	16	3D	5	A (IP65)	24
	12W	R	22	T	8	B (IP68)	120
	13W	G	25	S	10		230
	14W	B	38	R			
	15W	RGB+W (27K, 30K, 35K, 40K, 50K, 65K)	and more...				
		TW(Tunable White)					

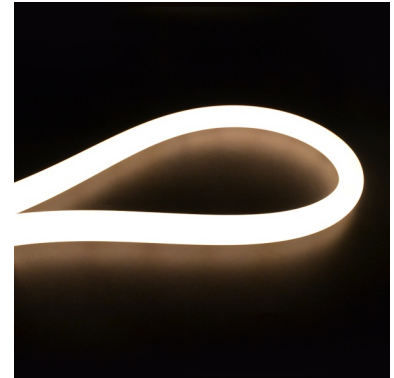

Example: FN15W-TW25-R10A24

MECHANICAL DIAGRAMS

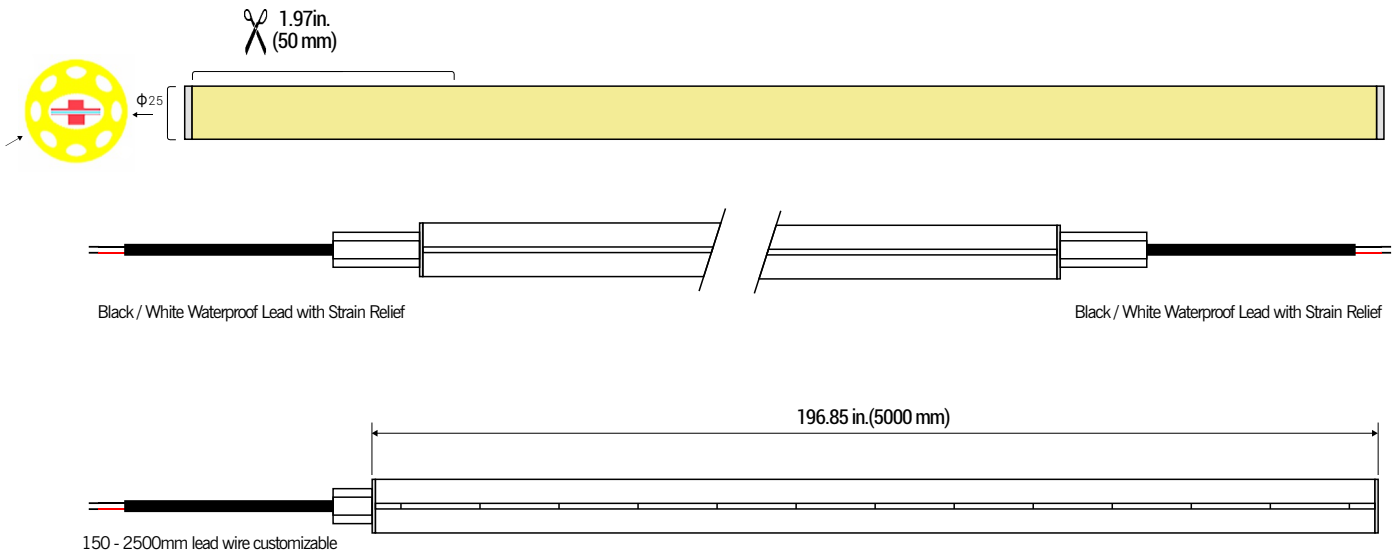

Lead Wire Options

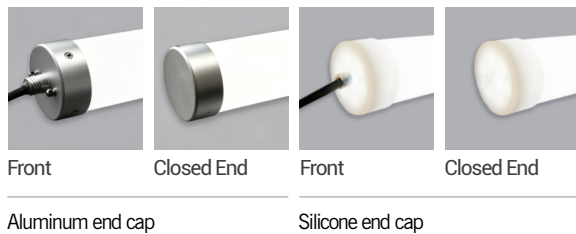

Round 360°

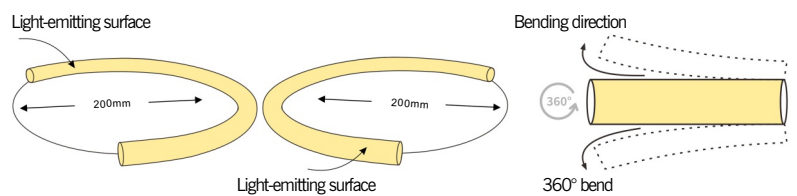

Use professional scissors to cut vertically at the cutting mark.

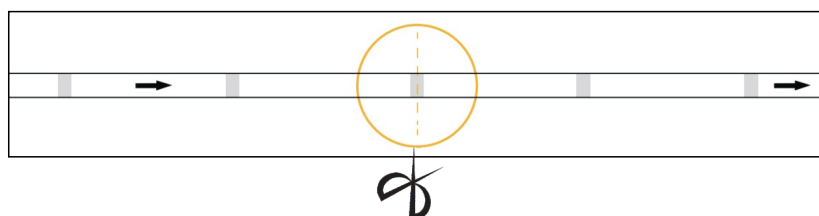

25mm Round 360° Dynamic CCT LED Neon

Features and Specifications



Mounting Option 1 (PC Bracket)

Secure the PC Bracket to the mounting surface with screws at intervals of at least every 250mm. Once secured, press the Neon Strip firmly into the PC Bracket.

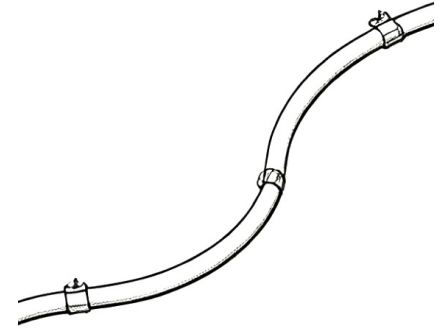
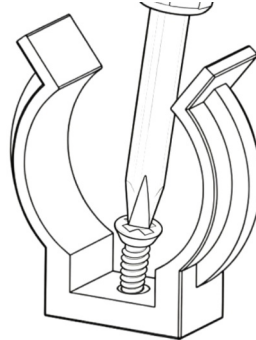
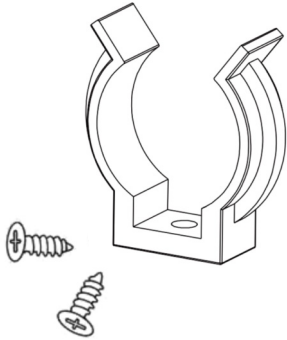

Mounting Option 2 (Pendant)

Fix the ceiling mount base firmly on the mounting surface with screws. Connect the steel wire to the hanging point of the neon strip. Hang the steel wire onto the ceiling bracket and adjust the height to your desired position. Tighten the fixing screws to secure the suspension firmly. Align the power connector correctly, then connect the power supply. Check all installation parts before powering on.

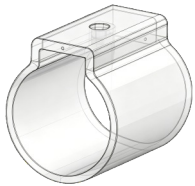

PC Lifting Ring

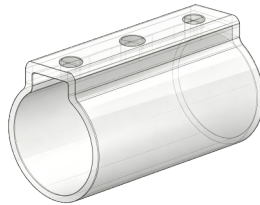

PC Splicing Lifting Ring



Pendant Kit

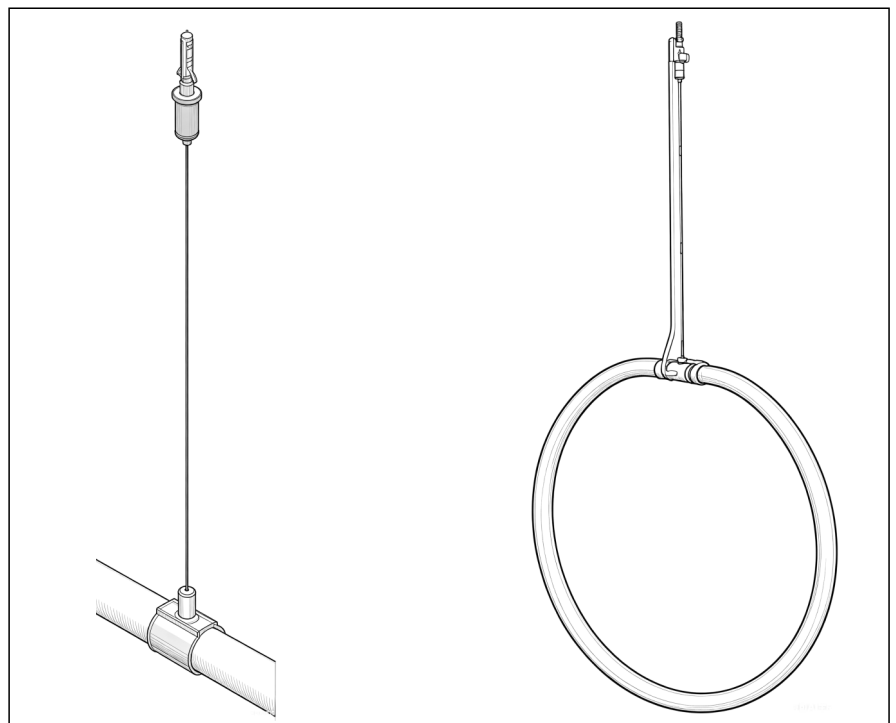
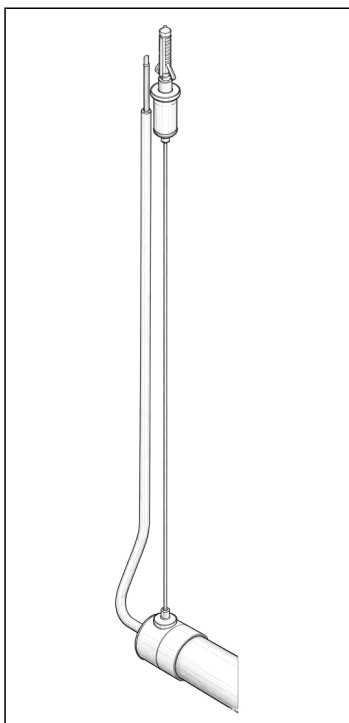

25mm Round 360° Dynamic CCT LED Neon

Features and Specifications



Mounting Option 3 (360° Swivel Bracket)

Secure the 360° swivel bracket firmly to the wall or ceiling using the included screws and wall anchors, then insert the neon strip into the 360° swivel bracket, which features a 360° rotatable ball joint that allows you to freely adjust the direction and angle of the neon strip to achieve your desired lighting effect.

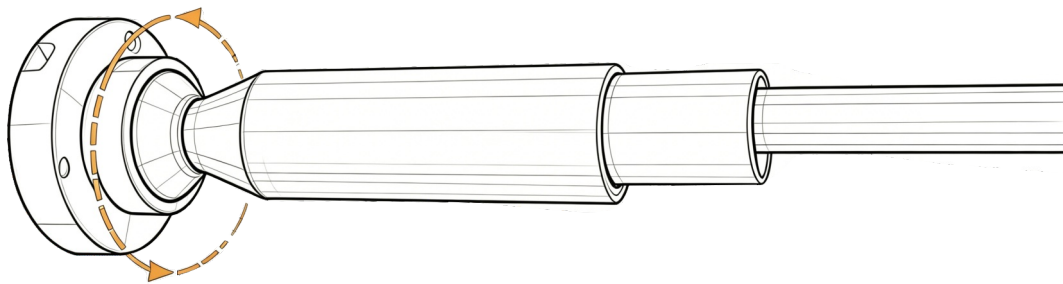
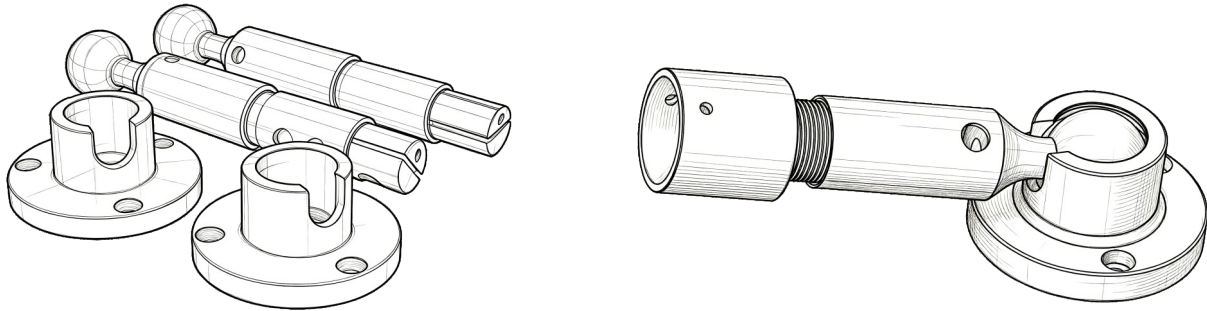

360° Rotatable



25mm Round 360° Dynamic CCT LED Neon

Features and Specifications



System Wiring Diagrams

The diagram below illustrates a standard system configuration. For larger installations or custom setups, please visit our website or contact technical support. Before beginning, consult the specific installation guides for each component to ensure you have the most current wiring instructions. All installations must comply with national and local electrical codes. Note that wiring configurations may vary depending on your specific power and dimming requirements.

Tunable White System Diagram

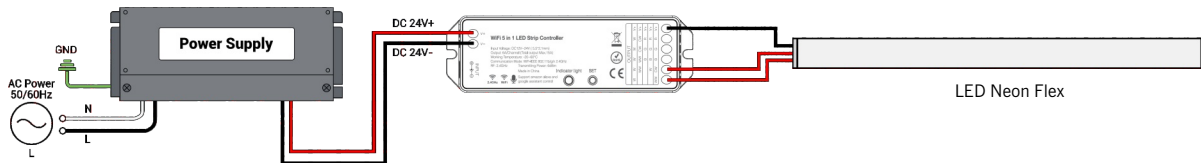

Common Controllers for LED Neon and Tape Light

Panel Controller 2.4G RF



P0 (Black)
2 in 1 Rotating Panel Controller
(Single Color / Dual White)



P0 (White)
2 in 1 Rotating Panel Controller
(Single Color / Dual White)

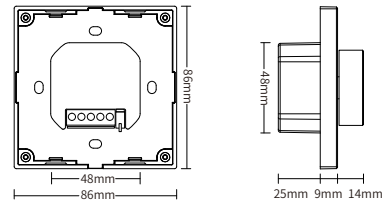

Model No.	Output Mode	Output Current	Input Voltage	Total Output	Output Power	Working Temp.	Control Signal	Control Distance
P0	2 in 1	DC12V~48V	12A/Channel	Max 12A	144-576W	-10~40°C	2.4G RF	30m

2.4G+Wifi Series (built in wifi chip, no need gateway)

5 in 1 LED Controller Tuya WiFi + 2.4G RF

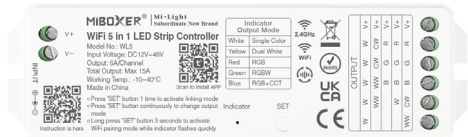

5 in 1 LED Controller
(Single Color / Dual White / RGB / RGBW / RGB+CCT)

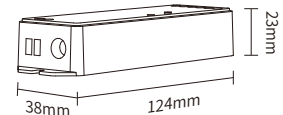

Model No.	Output Mode	Input Voltage	Output Current	Total Output	Output Power	Working Temp.	Control Signal	2.4G RF Distance
WLS5	5 in 1	DC12V~48V	6A/Channel	Max 15A	180-720W	-10~40°C	Tuya app + 2.4G RF	30m

2.4G LED Controller Kits 2.4G RF

Controller kits: save money, cheaper than you purchase controller and remote separately.



FUT035SA+
2 in 1 LED Controller Kits
(Single Color / Dual White)

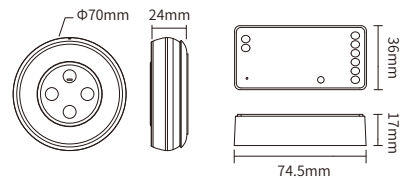

Remote Parameters

Working Voltage	Standby Power Consumption	Transmitting Power	RF	Working Temp.	Control Distance
3V(AAA * 2PCS)	15μA	6dBm	2.4GHz	-10~40°C	30m

Controller Parameters

Model No.	Output Mode	Input Voltage	Output Current	Total Output	Output Power	Working Temp.	Control Signal	Control Distance
FUT035SA+	2 in 1	DC12V~24V	12A/Channel	Max 12A	144-288W	-10~40°C	2.4G RF + PUSH	30m

25mm Round 360° Dynamic CCT LED Neon

Features and Specifications



Waterproof 5 in 1 LED Controller



WLS-WP   + 2.4G RF 
5 in 1 LED Controller
(Single Color / Dual White / RGB / RGBW / RGB+CCT)

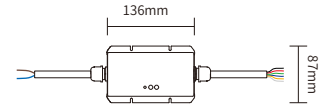
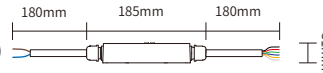

Model No.	Output Mode	Input Voltage	Output Current	Total Output	Output Power	Working Temp.	Control Signal	2.4G RF Distance
WLS-WP	5 in 1	DC12V~48V	10A/Channel	Max 20A	240-960W	-20~45°C	Tuya app + 2.4G RF	30m

Power Supplies for LED Neon and Tape Light

Constant Voltage Metal Power Supply (Non-waterproof, IP20)



Model No.	AC input voltage range	Output
SL-V-12XXXM (SL-V-24XXXM)	100-240V	DC 12V or 24V, Max. Output Options: 15W,35W,50W,60W,70W,100W,120W,200W,250W,300W,350W,400W,500W,600W

Constant Voltage Metal Power Supply (Non-waterproof, IP20)



Model No.	AC input voltage range	Output
SL-V-12XXXPU (SL-V-24XXXPU)	90-264V	DC 12V or 24V, Max. Output Options: 12W,24W
SL-V-12XXXP (SL-V-24XXXP)	90-264V	DC 12V or 24V, Max. Output Options: 36W,48W,60W

Constant Voltage Power Supply (Waterproof, IP67)



Model No.	AC input voltage range	Output
SL-V-12XXXM (SL-V-24XXXM)	170-250V	DC12V or 24V, Max. Output Options Output : 10W, 20W, 30W, 45W, 60W, 100W, 150W, 200W